

**ALKALINE-MANGANESE DIOXIDE BATTERY**

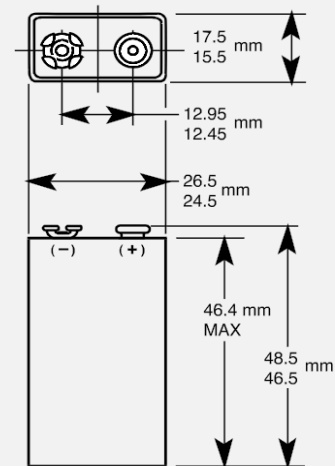

size: 9V (6LR61) PC1604



Dimensions shown are IEC standards

**KEY FEATURES**

- Reliable Performance
- Excellent resistance to corrosion
- Designed to meet all major quality, safety and environmental standards:
  - Safety: IEC 60086-5
  - ANSI C 18.1M, Part-2
  - EU Battery Directive
  - Quality: ISO 14001 and 9001, Duracell World Class Continuous Improvement Program

**TYPICAL APPLICATIONS**

- Carbon Monoxide Detectors
- Smoke Detectors
- Multimeters
- Medical Devices
- Microphones

**ELECTRICAL CHARACTERISTICS**

- Nominal capacity (2 mA Cont., 5V cut-off) 673 mAh
- Typical Voltage (at + 20 °C) 9 V
- AC Impedance @ 1kHz 1,700 mΩ

**PHYSICAL CHARACTERISTICS**

- Typical weight 45.0 g (1.6 oz)
- Typical volume 22.8 cm<sup>3</sup> (1.4 in<sup>3</sup>)
- Terminals Miniature snap

**OPERATING & STORAGE CONDITIONS**

- Operating temperature range -20°C to 54°C  
(-4°F to 130°F)
- Recommended Storage (storage area should be clean, cool, dry and ventilated) 5°C to 30°C  
(41°F to 86°F)

TYPICAL PERFORMANCE

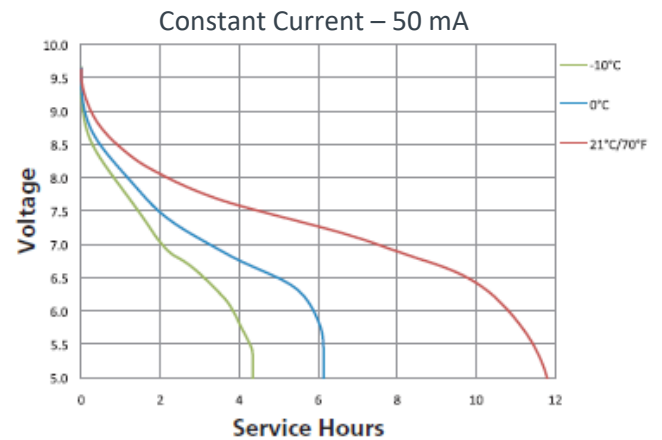
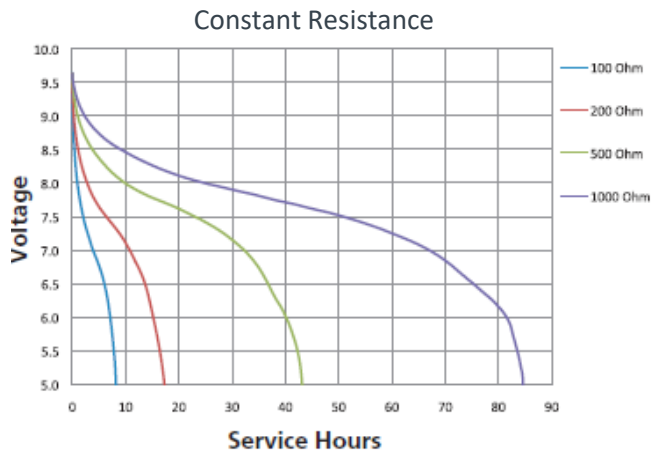
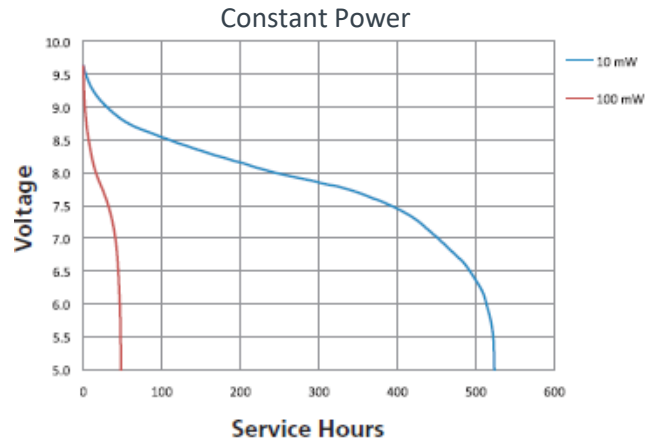
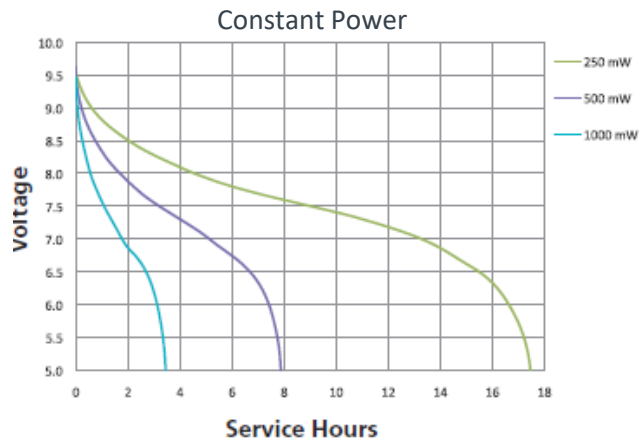
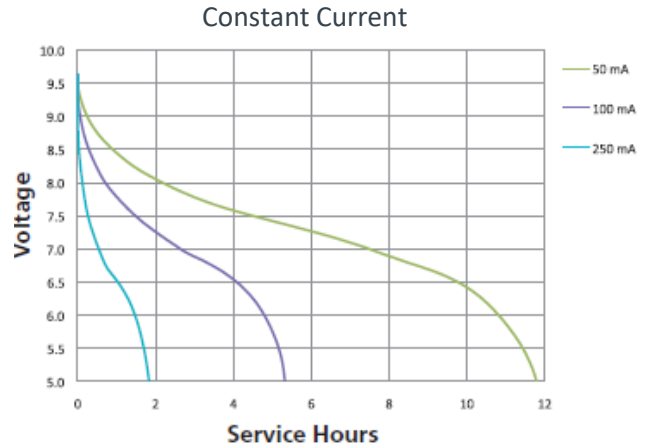
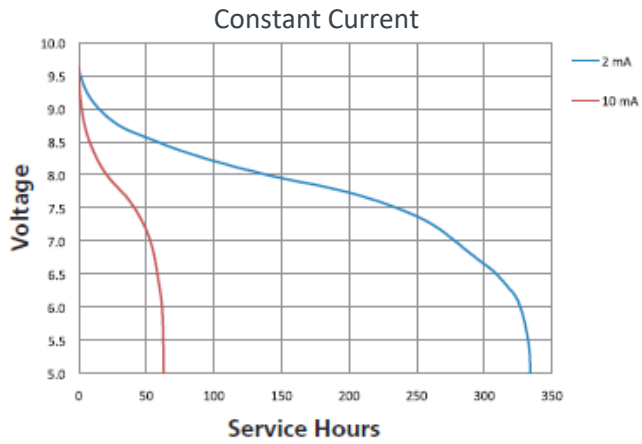

**PROCELL**<sup>®</sup>  
PROFESSIONAL BATTERIES  
Duracell Industrial Operations  
Berkshire Corporate Park  
Phone: 1-800-544-5454 (Toll-free)  
[www.procell.com](http://www.procell.com)

Delivered capacity is dependent on the applied load, operating temperature and cut-off voltage. Please refer to the charts and discharge data shown for examples of the energy/service life that the battery will provide for various load conditions.

This data is subject to change. Performance information is typical. Contact Duracell for the latest information.