

Specifications

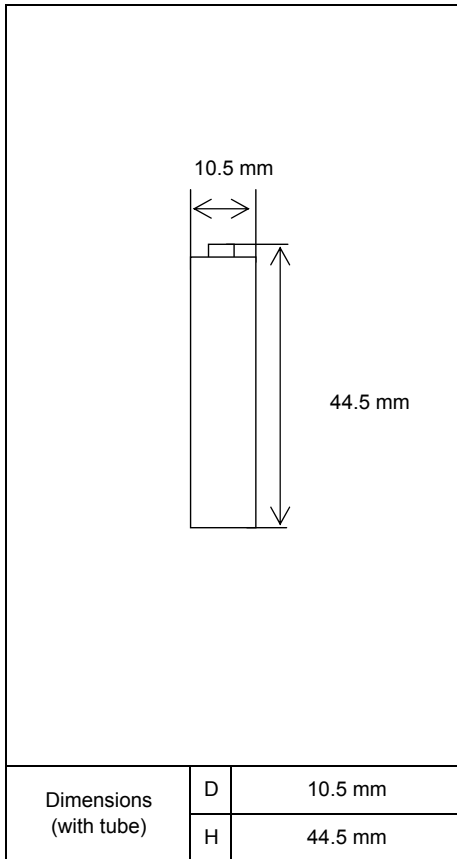

Type : Nickel-Metal Hydride Battery		Size : AAA Consumer Type
Capacity ¹⁾	Typical	600mAh
	Minimum	550mAh
Nominal Voltage		1.2V
Charging Current x Time	Fast Charge ²⁾	600 mA x about 1.1h
Ambient Temp.	Charge Condition	Fast Charge ²⁾ 0°C - 40°C
	Discharge Condition 0°C - 50°C	
	Storage Condition	Less than 90days
Less than 1year		-20°C - 30°C
Internal Impedance ³⁾ (after discharge to E.V.=1.0V)		Approx. 40mΩ (at 1000Hz)
Weight ⁴⁾		Approx. 11 g
Size ⁴⁾ : (Diameter) x (Height)		10.5(D) x 44.5(H) mm

- 1) Single cell capacity under the following condition.
Charge : 60mA×16h, Discharge : 120mA(E.V.=1.0V) at 20°C
- 2) Use recommended charging system.
- 3) After a few charge and discharge cycles under the above 1) condition.
- 4) With tube.

Typical Characteristics

Charge

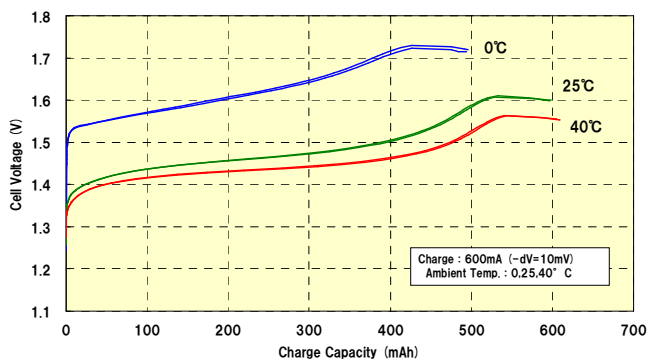

Discharge

